

Owner's Manual & Safety Instructions

Save This Manual Keep this manual for the safety warnings and precautions, assembly, operating, inspection, maintenance and cleaning procedures. Write the product's serial number in the back of the manual near the assembly diagram (or month and year of purchase if product has no number). Keep this manual and the receipt in a safe and dry place for future reference.

PREDATOR™ GENERATORS

6500 WATT PORTABLE GENERATOR

**5500 RATED WATTS
6500 MAX WATTS**

- 420cc Air Cooled OHV Gas Engine
- 12 Hour Run Time at 50% Capacity
- Low Oil Indicator / Low Oil Shutdown
- Heavy Duty 1-1/4" Steel Roll Cage
- UL Listed Circuit Breaker



⚠ DANGER

Using a generator indoors CAN KILL YOU IN MINUTES.

Generator exhaust contains carbon monoxide. This is a poison you cannot see or smell.

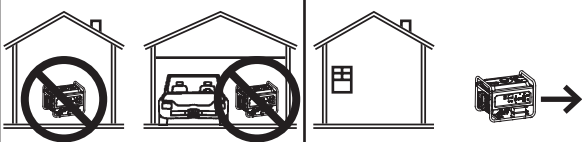

NEVER use inside a home or garage, **EVEN IF** doors and windows are open.

Only use **OUTSIDE** and far away from windows, doors, and vents.

ITEM 69672 / 69674

Visit our website at: <http://www.harborfreight.com>
Email our technical support at: tech@harborfreight.com
Email our Engine support at: predator@harborfreight.com

When unpacking, make sure that the product is intact and undamaged. If any generator parts are missing or broken, please call 1-800-444-3353 as soon as possible. If any engine parts are missing or broken, please call 1-800-520-0882 as soon as possible.

Copyright© 2012 by Harbor Freight Tools®. All rights reserved.

No portion of this manual or any artwork contained herein may be reproduced in any shape or form without the express written consent of Harbor Freight Tools. Diagrams within this manual may not be drawn proportionally. Due to continuing improvements, actual product may differ slightly from the product described herein. Tools required for assembly and service may not be included.

⚠ WARNING

Read this material before using this product. Failure to do so can result in serious injury. SAVE THIS MANUAL.





Table of Contents

Safety	2	Maintenance	14
Setup	6	Parts List and Diagram	19
Specifications	6	Warranty	23
Operation	8		

SAFETY

PREDATOR™ GENERATORS

WARNING SYMBOLS AND DEFINITIONS

	This is the safety alert symbol. It is used to alert you to potential personal injury hazards. Obey all safety messages that follow this symbol to avoid possible injury or death.
	Indicates a hazardous situation which, if not avoided, will result in death or serious injury.
	Indicates a hazardous situation which, if not avoided, could result in death or serious injury.
	Indicates a hazardous situation which, if not avoided, could result in minor or moderate injury.
	Addresses practices not related to personal injury.

SETUP

IMPORTANT SAFETY INSTRUCTIONS

INSTRUCTIONS PERTAINING TO A RISK OF FIRE, ELECTRIC SHOCK, OR INJURY TO PERSONS

WARNING – When using tools, basic precautions should always be followed, including the following:

Set up Precautions

1. Gasoline fuel and fumes are flammable, and potentially explosive. Use proper fuel storage and handling procedures. Do not store fuel or other flammable materials nearby.
5. All connections and conduits from the Generator to the load must only be installed by trained and licensed electricians, and in compliance with all relevant local, state, and federal electrical codes and standards, and other regulations where applicable.
2. Have multiple ABC class fire extinguishers nearby.
6. Connections for standby power to a building electrical system must be made by a qualified electrician. The connection must isolate the generator power from utility power, and must comply with all applicable laws and electrical codes.
3. Operation of this equipment may create sparks that can start fires around dry vegetation. A spark arrestor may be required. The operator should contact local fire agencies for laws or regulations relating to fire prevention requirements.
7. Wear ANSI-approved safety goggles, heavy-duty work gloves, and dust mask/respirator during set up.
4. Set up and use only on a flat, level, well-ventilated surface.
8. Use only lubricants and fuel recommended in this manual.

OPERATION

MAINTENANCE

Set up Precautions (cont.)

- Improper connections to a building electrical system can allow electrical current from the generator to backfeed into the utility lines. Such backfeed may electrocute utility company workers or others who contact the lines during a power outage, and the generator may explode, burn, or cause fires when utility power is restored. Consult the utility company and a qualified electrician if intending to use the generator for back up power.
- Do not operate the Generator before grounding. The Generator must be earth-grounded in accordance with all relevant electrical codes and standards before operation.

Operating Precautions

- 

CARBON MONOXIDE HAZARD
Using a generator indoors CAN KILL YOU IN MINUTES.
Generator exhaust contains carbon monoxide. This is a poison you cannot see or smell.

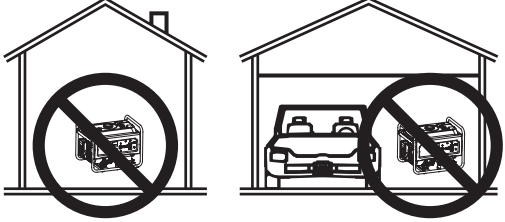

NEVER use inside a home or garage, EVEN IF doors and windows are open.

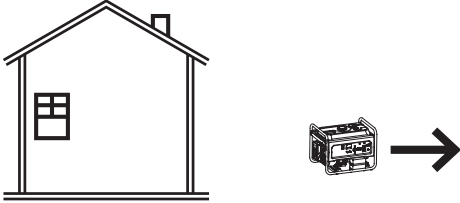

Only use OUTSIDE and far away from windows, doors, and vents.
- Never use a generator indoors, including in garages, basements, crawlspaces and sheds. Opening doors and windows or using fans will NOT prevent carbon monoxide build up in the home.
- When using generators, keep them outdoors and far away from open doors, windows, and vents to avoid toxic levels of carbon monoxide from building up indoors.
- If you start to feel sick, dizzy, or weak while using a generator, get to fresh air right away. The carbon monoxide from generators can quickly lead to full incapacitation and death.
- Keep children away from the equipment, especially while it is operating.
- Keep all spectators at least six feet from the Engine during operation.
- Fire Hazard! Do not fill gas tank while engine is running. Do not operate if gasoline has been spilled. Clean spilled gasoline before starting engine. Do not operate near pilot light or open flame.
- Do not touch engine during use. Let engine cool down after use.
- Never store fuel or other flammable materials near the engine.
- If the plugged in product operates abnormally or unusually slow, immediately stop using the generator as a power source. Always read and adhere to the instruction manual of the product to be powered, to make sure that it can be safely and efficiently powered by a portable generator.
- Before connecting an appliance or power cord to the generator: Make sure that it is in good working order. Faulty appliances or power cords can create a potential for electrical shock.
- Do not exceed the maximum power rating of the generator. Make sure that the total electrical rating of the all of the tools or appliances plugged into the generator at the same time does not exceed that of the generator. Check that the startup surge will not be beyond the limit of the Generator. Power levels between rated and maximum may be used for no more than 30 minutes.
- Avoid substantially overloading which will trip the circuit breaker. Exceeding the time limit for maximum power operation or slightly overloading the generator may not switch the circuit breaker or circuit protector OFF, but will shorten the service life of the generator.
- Do not attempt to connect or disconnect load connections while standing in water, or on wet or soggy ground.
- Do not touch electrically energized parts of the Generator and interconnecting cables or conductors with any part of the body, or with any non-insulated conductive object.

Operating Precautions (cont.)

SAFETY

16. Connect the Generator only to a load or electrical system (120 volt or 240 volt) that is compatible with the electrical characteristics and rated capacities of the Generator.
17. Insulate all connections and disconnected wires.
18. Guard against electric shock. Prevent body contact with grounded surfaces such as pipes, radiators, ranges, and refrigerators.
19. Only use a suitable means of transport and lifting devices with sufficient weight bearing capacity when transporting the generator.

SETUP

20. Secure the Generator on transport vehicles to prevent the tool from rolling, slipping, and tilting.
21. Industrial applications must follow OSHA requirements.
22. Do not leave the Generator unattended when it is running. Turn off the Generator (and remove safety keys, if available) before leaving the work area.
23. The Generator engine can produce high noise levels. Prolonged exposure to noise levels above 85 dBA is hazardous to hearing. Always wear ear protection when operating or working around the gas engine while it is operating.

OPERATION

24. Wear ANSI-approved safety glasses, hearing protection, and NIOSH-approved dust mask/respirator during use.
25. People with pacemakers should consult their physician(s) before use. Electromagnetic fields in close proximity to a heart pacemaker could cause pacemaker interference or pacemaker failure. Caution is necessary when near the engine's magneto or recoil starter.
26. Use only accessories that are recommended by Harbor Freight Tools for your model. Accessories that may be suitable for one piece of equipment may become hazardous when used on another piece of equipment.

MAINTENANCE

27. Do not operate in explosive atmospheres, such as in the presence of flammable liquids, gases, or dust. Gasoline-powered engines may ignite the dust or fumes.
28. Keep grounded conductive objects, such as tools, away from exposed, live electrical parts and connections to avoid sparking or arcing. These events could ignite fumes or vapors.

29. Stay alert, watch what you are doing and use common sense when operating this piece of equipment. Do not use this piece of equipment while tired or under the influence of drugs, alcohol or medication.
30. Dress properly. Do not wear loose clothing or jewelry. Keep hair, clothing and gloves away from moving parts. Loose clothes, jewelry or long hair can be caught in moving parts.
31. Parts, especially exhaust system components, get very hot during use. Stay clear of hot parts.
32. Do not cover the generator or its engine during operation.
33. Keep the generator, its engine, and surrounding area clean at all times.
34. Use the generator, accessories, etc., in accordance with these instructions and in the manner intended for the particular type of equipment, taking into account the working conditions and the work to be performed. Use of the equipment for operations different from those intended could result in a hazardous situation.
35. Do not operate the generator with known leaks in the engine's fuel system.
36. This product contains or, when used, produces a chemical known to the State of California to cause cancer and birth defects or other reproductive harm. (California Health & Safety Code § 25249.5, *et seq.*)
37. When spills of fuel or oil occur, they must be cleaned up immediately. Dispose of fluids and cleaning materials as per any local, state, or federal codes and regulations. Store oil rags in a bottom-ventilated, covered, metal container.
38. Keep hands and feet away from moving parts. Do not reach over or across generator while operating.
39. Before use, check for misalignment or binding of moving parts, breakage of parts, and any other condition that may affect the generator's operation. **If damaged, have the generator serviced before using.** Many accidents are caused by poorly maintained equipment.
40. Use the correct generator for the application. Do not modify the generator or its engine, and do not use the generator for a purpose for which it is not intended.

Service Precautions

1. **Before service, maintenance, or cleaning:**
 - a. **Unplug all devices from the generator.**
 - b. **Turn the engine switch to its “OFF” position.**
 - c. **Allow the engine to completely cool.**
 - d. **Then, remove the spark plug cap from the spark plug.**
2. Keep all safety guards in place and in proper working order. Safety guards include muffler, air cleaner, mechanical guards, and heat shields, among other guards.
3. Make sure the Engine Switch is in its “OFF” position before moving the Generator and before performing any service, maintenance, or cleaning procedures on the unit.
4. Keep all electrical equipment clean and dry. Replace any wiring where the insulation is cracked, cut, abraded, or otherwise degraded. Replace terminals that are worn, discolored, or corroded. Keep terminals clean and tight.
5. **Do not alter or adjust any part of the equipment or its engine that is sealed by the manufacturer or distributor. Only a qualified service technician may adjust parts that may increase or decrease governed engine speed.**
6. Wear ANSI-approved safety goggles, heavy-duty work gloves, and dust mask/respirator during service.
7. Maintain labels and nameplates on the equipment. These carry important information. If unreadable or missing, contact Harbor Freight Tools for a replacement.
8. Have the equipment serviced by a qualified repair person using only identical replacement parts. This will ensure that the safety of the equipment is maintained. Do not attempt any service or maintenance procedures not explained in this manual or any procedures that you are uncertain about your ability to perform safely or correctly.
9. Store equipment out of the reach of children.
10. Follow scheduled engine and equipment maintenance.

Refueling:

1. Do not smoke, or allow sparks, flames, or other sources of ignition around the equipment, especially when refuelling.
2. Do not refill the fuel tank while the engine is running or hot.
3. **TO PREVENT FUEL LEAKAGE AND FIRE HAZARD, Do not overfill with fuel. Fill with fuel according to the Fuel Level information below the Specification chart for your model.**
4. Do not fill fuel tank to the top. Leave a little room for the fuel to expand as needed.
5. Refuel in a well-ventilated area only.
6. Wipe up any spilled fuel and allow excess to evaporate before starting engine. **To prevent FIRE, do not start the engine while the smell of fuel hangs in the air.**



SAVE THESE INSTRUCTIONS.

PREDATOR™
GENERATORS

Functional Description

Specifications

Generator	Rated Output	120/240V~, 60Hz 5,500 Watts (6,500 max)		
	Electrical Receptacle	Two 3-Prong, duplex NEMA #5-20 120V One 4-Prong, NEMA #L14-30 twistlock 120V/240V One DC Outlet 12VDC		
Engine	Displacement	420cc		
	Engine Type	Horizontal Single Cylinder 4 stroke OHV EPA phase III compliant		
	Cooling System	Forced air cooled		
	Fuel	Type	87+ octane unleaded gasoline	
		Capacity	6.1 Gallons (23L)	
	Engine Oil	Type SAE	10W-30 above 32° F 5W-30 at 32° F or below	
		Capacity	1.16 Quart (1.1L)	
	Run Time @ 50% load	12 hr.		
Operational Volume	74 dB			
Available accessories		Wheel kit (sold separately)		

Item 69674 - The emission control system for this Generator's Engine is warranted for standards set by the U.S. Environmental Protection Agency and by the California Air Resources Board (also known as CARB). For warranty information, refer to the last pages of this manual.

Item 69672 - The emission control system for this Generator's Engine is warranted for standards set by the U.S. Environmental Protection Agency. For warranty information, refer to the last pages of this manual.

Components and Controls

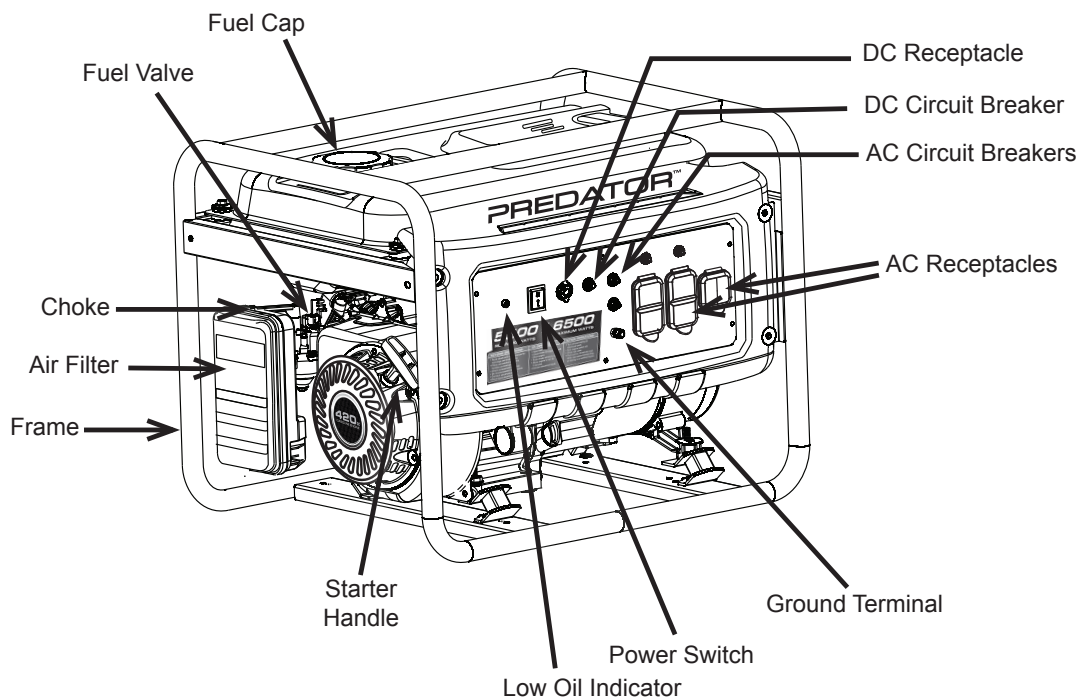

Components and Controls (cont.)

The following are descriptions of the controls on the power panel. Your generator has sockets to power your products with circuit breakers to protect the voltage flow.

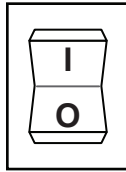

1. **Engine Switch:** Used to enable/disable Generator operation..
2. **AC Receptacles:** The Generator contains several AC receptacles to power tools and equipment.



- a. **3-Prong, duplex 120 volt receptacle (NEMA #5-20)**



- a. **4-Prong, twistlock, 120/240 volt receptacle (NEMA #L14-30)**

⚠WARNING! Connect tools and equipment only to the Receptacle (120 volt or 240 volt) that is compatible with the electrical characteristics and rated capacities of the tools and equipment being used.



3. **Circuit Breakers:** The circuit breaker protects the Generator from overloading. The rating of the breaker and the load it protects are marked near the breaker. Should any of the Circuit Breakers trip, the Generator will stop the electricity output. If this happens, unplug all loads from the Generator. Allow the Generator to cool down. Then, press the tripped Circuit Breaker, restart the Engine, and re-attach loads.



4. **DC Receptacle:** 12 VDC Receptacle set provides a power source for 12 volt DC items.



5. **Grounding Terminal:** Prior to each use, set up the ground wire (not included) connection to the Grounding Terminal to properly ground the Generator. See Set up instructions to properly ground the Generator.

SAFETY

SETUP

OPERATION

MAINTENANCE

Initial Tool Set Up/Assembly



Read the **ENTIRE IMPORTANT SAFETY INFORMATION** section at the beginning of this manual including all text under subheadings therein before set up or use of this product.

Note: For additional information regarding the parts listed in the following pages, refer to the Assembly Diagram near the end of this manual.

WARNING

TO PREVENT SERIOUS INJURY:
Operate only with proper spark arrestor installed.

Operation of this equipment may create sparks that can start fires around dry vegetation. A spark arrestor may be required. The operator should contact local fire agencies for laws or regulations relating to fire prevention requirements.

Grounding

The Generator must be properly grounded before use. Have the unit grounded by a qualified electrician if you are not qualified to do so.

To ground the Generator, connect a #6 AWG grounding wire (not included) from the Grounding Terminal on the Control Panel to a grounding rod (not included) that has been driven at least 24 inches deep into the earth. The grounding rod must be an earth-driven copper or brass rod (electrode) which can adequately ground the Generator.

Operating Instructions



Read the **ENTIRE IMPORTANT SAFETY INFORMATION** section at the beginning of this manual including all text under subheadings therein before set up or use of this product.

Inspect tool before use, looking for damaged, loose, and missing parts. If any problems are found, do not use tool until repaired.

Generator Pre-Start Checks

Inspect engine and equipment, looking for damaged, loose, and missing parts before set up and starting. If any problems are found, do not use equipment until fixed properly.

Checking and Filling Engine Oil

CAUTION! Your Warranty is VOID if the engine's crankcase is not properly filled with oil before each use. Before each use, check the oil level. Do not run the engine with low or no engine oil. Running the engine with no or low engine oil WILL permanently damage the engine.

1. Make sure the engine is stopped and is level.
2. Close the Fuel Valve.
3. Clean the top of the Dipstick and the area around it. Remove the Dipstick by threading it counterclockwise, and wipe it off with a clean lint free rag.

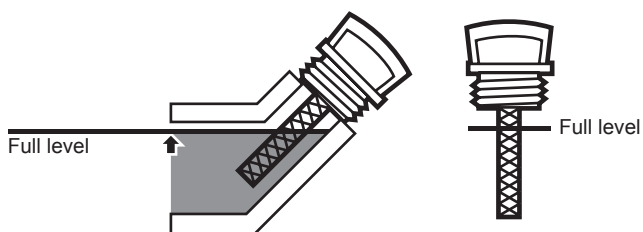

4. Reinsert the Dipstick without threading it in and remove it to check the oil level. The oil level should be up to the full level as shown above.
5. If the oil level is at or below the low mark add the appropriate type of oil until the oil level is at the proper level. SAE 10W-30 oil is recommended for general use. (The SAE Viscosity Grade chart on page 15 in the User-Maintenance Instructions section shows other viscosities to use in different average temperatures.)
6. Thread the dipstick back in clockwise.

CAUTION! Do not run the engine with too little oil. The engine will be permanently damaged.

Checking and Filling Fuel



WARNING! TO PREVENT SERIOUS INJURY FROM FIRE:

Fill the fuel tank in a well-ventilated area away from ignition sources. If the engine is hot from use, shut the engine off and wait for it to cool before adding fuel.

Do not smoke.

1. Clean the Fuel Cap and the area around it.
2. Unscrew and remove the Fuel Cap.
3. If needed, fill the Fuel Tank to about 1 inch under the fill neck of the Fuel Tank with 87 octane or higher unleaded gasoline.

Note: Do not use gasoline containing more than 10% ethanol (E10). Do not use E85 ethanol.

Note: Do not use gasoline that has been stored in a metal fuel container or a dirty fuel container. It can cause particles to enter the carburetor, effecting engine performance and/or causing damage.

4. Then replace the Fuel Cap.
5. Wipe up any spilled fuel and allow excess to evaporate before starting engine. To prevent FIRE, do not start the engine while the smell of fuel hangs in the air.

Using the Generator

Before Starting the Generator Engine



Before starting the engine:

- a. Follow the Set Up Instructions to prepare the Generator.
- b. Unplug all loads from the Generator.
- c. Inspect the Generator and engine.
- d. Fill the engine with the proper amount and type of both fuel and oil.

Basic Generator Use Procedure - See following pages for specific instructions

1. Check that the generator can handle the wattage needed to power your products.
2. Start the Engine, and allow the Engine and Generator to run and warm up for five minutes after starting with no electrical load.
3. Plug in products.
4. When finished using the Generator, disconnect all electrical loads.

Note: Do not allow generator to run out of fuel with loads attached.

5. Turn off the Engine.

Allow the Generator and its Engine to completely cool. Then store the unit in a clean, dry, safe location out of reach of children and other unauthorized people.

IMPORTANT: After starting the engine, allow it to run at no load for five minutes with no load after each start-up so that the engine can stabilize.

6. Break-in Period:
 - a. Breaking-in the engine will help to ensure proper equipment and engine operation.
 - b. The operational break-in period will last about 3 hours of use. During this period:
 - Do not apply a heavy load to the equipment.
 - c. The maintenance break-in period will last about 20 hours of use. After this period:
 - Change the engine oil.

Under normal operating conditions subsequent maintenance follows the schedule explained in the SERVICE section.

Starting the Engine

SAFETY

1. To start a cold engine, move the Choke to the CHOKE position.
To restart a warm engine, leave the Choke in the RUN position.

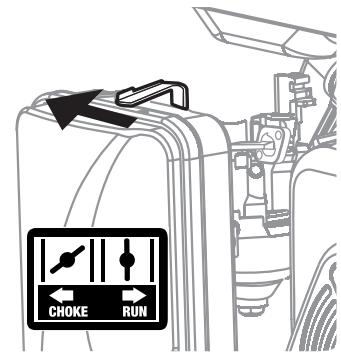

SETUP

2. Open the Fuel Valve.

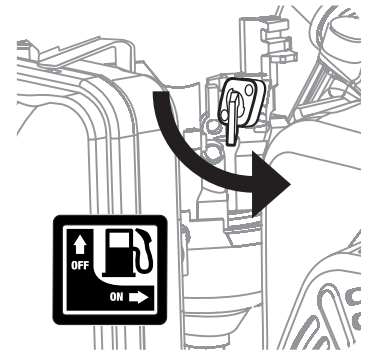

OPERATION

3. Turn the Engine Switch to ON.

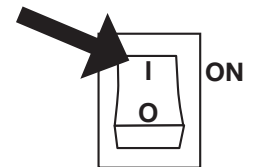

4. Grip the Starter Handle of the Engine loosely and pull it slowly several times to allow the gasoline to flow into the Engine's carburetor. Then pull the Starter Handle gently until resistance is felt. Allow Cable to retract fully and then pull it quickly. Repeat until the engine starts.
Note: Do not let the Starter Handle snap back against the engine. Hold it as it recoils so it doesn't hit the engine.

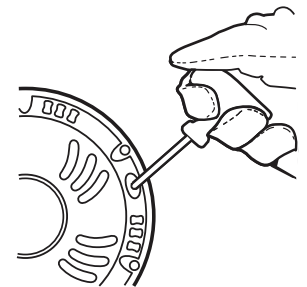

MAINTENANCE

5. Allow the Engine to run for several seconds.
Then, if the Choke lever is in the CHOKE position, move the Choke Lever very slowly to its RUN position.

NOTE: Moving the Choke Lever too fast could stall the engine.

IMPORTANT: Allow the engine to run at no load for five minutes with no load after each start-up so that the engine can stabilize.

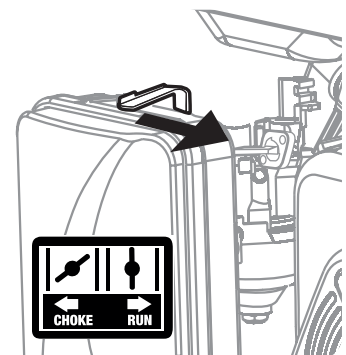

Connecting Electrical Loads

Familiarize yourself with the engine controls, power panel and how to start the engine before using the generator. Calculate the wattage of the products you will use with the generator and verify that the generator can handle the total load.

⚠ WARNING! Connect only properly wired plugs to the generator. A plug that is spliced onto a different cord may be hazardous. Only a qualified electrician should wire a plug onto a cord.

CAUTION Never exceed the rated capacity for this Generator, as serious damage to the Generator and/or appliances, tools, and equipment could result from an overload. Starting and running wattage requirements should always be calculated when matching this Generator's wattage capacity to the appliance, tool, or equipment.

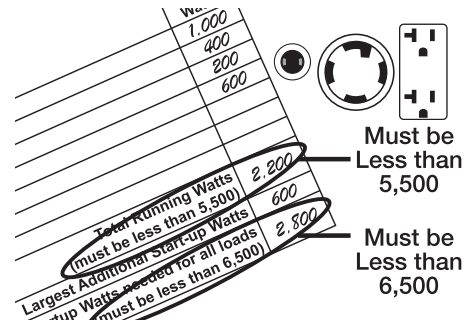

Use the DC12V Receptacle to power 12VDC equipment.

⚠ WARNING! Do not charge batteries without a proper charge controller. Do not overcharge.

- Connect the items that require the most wattage first.
- Connect "inductive" load appliances, tools, and equipment next. Inductive loads are small hand tools and some small appliances.
- Connect any lights next.
- Voltage sensitive appliances, tools, and equipment should be the last to be connected to the Generator. Plug voltage sensitive items such as TV's, DVD players, microwaves, and cordless telephones into a UL® Listed voltage surge protector (not included). Then, connect the surge protector into the Generator.

IMPORTANT! Failure to connect and operate appliances, tools, and equipment in this sequence can cause damage to the Generator, appliances, tools, and equipment and will **void** the Warranty of this Generator.

NOTE: If Engine speed or voltage fluctuates with a load below the Generator's rated watts, move the Engine Choke Lever to the "HALF-CHOKE" position.

IF ANY CIRCUIT BREAKERS TRIP CHECK THE FOLLOWING:

- Make sure that **ALL circuit breakers** are reset before starting the generator again.
- Adjust the plugs so the loads are shared across outlet circuits.

To achieve rated output from the generator, distribute loads over outlets.

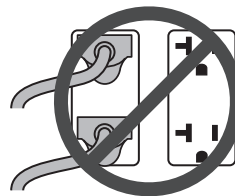

Evenly distributed over outlets:

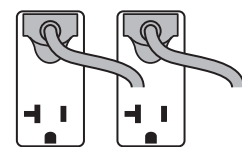

Stopping the Engine in an Emergency

1. To stop the engine in an emergency, turn the Engine Switch off.

NOTICE: Generator shut-off under load may damage the generator and attached equipment.

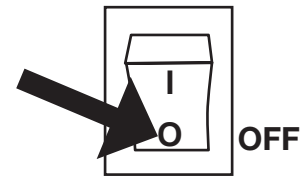

SAFETY

Stopping the Engine Under Normal Conditions

1. Before turning off the Engine, turn off all electrical loads, then unplug them.

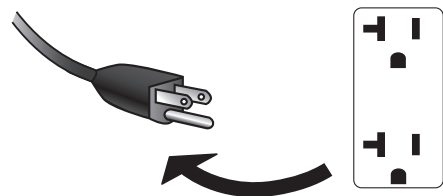

SETUP

2. Turn the Engine Switch off.

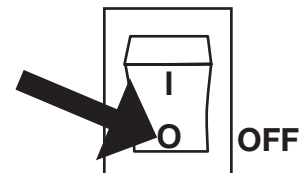

OPERATION

3. Close the Fuel Valve.

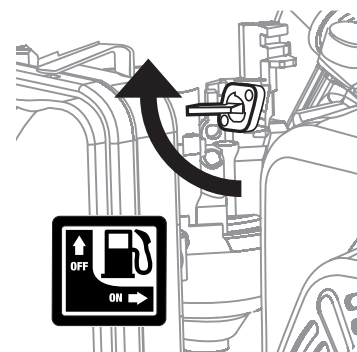

MAINTENANCE

User-Maintenance Instructions

⚠️ WARNING

TO PREVENT SERIOUS INJURY FROM ACCIDENTAL OPERATION:

Turn the Power Switch of the generator to its “OFF” position, wait for the engine to cool, and disconnect the spark plug cap before performing any inspection, maintenance, or cleaning procedures.

TO PREVENT SERIOUS INJURY FROM EQUIPMENT FAILURE:

Do not use damaged equipment. If abnormal noise, vibration, or excess smoking occurs, have the problem corrected before further use.

Follow all service instructions in this manual. The engine may fail critically if not serviced properly.



Many maintenance procedures, including any not detailed in this manual, will need to be performed by a qualified technician for safety. If you have any doubts about your ability to safely service the equipment or engine, have a qualified technician service the equipment instead.

Cleaning, Maintenance, and Lubrication

Note: This maintenance schedule is intended solely as a general guide. If performance decreases or if equipment operates unusually, check systems immediately. The maintenance needs of each piece of equipment will differ depending on factors such as duty cycle, temperature, air quality, fuel quality, and other factors.

Note: The following procedures are in addition to the regular checks and maintenance explained as part of the regular operation of the engine and equipment.

Procedure	Before Each Use	Monthly or every 20 hr. of use	Every 3 mo. or 50 hr. of use	Every 6 mo. or 100 hr. of use	Yearly or every 300 hr. of use	Every 2 Years
Brush off outside of engine	✓	✓	✓	✓	✓	✓
Check engine oil level	✓	✓	✓	✓	✓	✓
Check air cleaner	✓		✓	✓	✓	✓
Check deposit cup	✓			✓	✓	✓
Change engine oil		✓		✓	✓	✓
Clean/replace air cleaner			✓*	✓	✓	✓
Check and clean spark plug				✓	✓	✓
1. Check/adjust idle speed 2. Check/adjust valve clearance 3. Clean fuel tank, strainer and carburetor 4. Clean carbon build-up from combustion chamber					✓**	✓**
Replace fuel line if necessary						✓**

*Service more frequently when used in dusty areas.

**These items should be serviced by a qualified technician.

Checking and Filling Fuel



⚠WARNING! TO PREVENT SERIOUS INJURY FROM FIRE:

Fill the fuel tank in a well-ventilated area away from ignition sources. If the engine is hot from use, shut the engine off and wait for it to cool before adding fuel.

Do not smoke.

1. Clean the Fuel Cap and the area around it.
2. Unscrew and remove the Fuel Cap.
3. If needed, fill the Fuel Tank with 87 octane or higher unleaded gasoline.

Note: Do not use gasoline containing more than 10% ethanol (E10). Do not use E85 ethanol.

Note: Do not use gasoline that has been stored in a metal fuel container or a dirty fuel container. It can cause particles to enter the carburetor, effecting engine performance and/or causing damage.

4. Replace the Fuel Cap.
5. Wipe up any spilled fuel and allow excess to evaporate before starting engine. To prevent FIRE, do not start the engine while the smell of fuel hangs in the air.

Engine Oil Change

⚠CAUTION! Oil is very hot during operation and can cause burns. Wait for engine to cool before changing oil.

1. Make sure the engine is stopped and is level.
2. Close the Fuel Valve.
3. Place a drain pan (not included) underneath the crankcase's drain plug.
4. Remove the drain plug and, if possible, tilt the crankcase slightly to help drain the oil out. Recycle used oil.
5. Replace the drain plug and tighten it.
6. Clean the top of the Dipstick and the area around it. Remove the Dipstick by threading it counterclockwise, and wipe it off with a clean lint free rag.

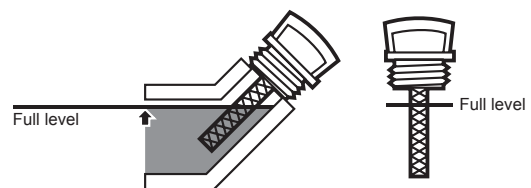

7. Add the appropriate type of oil until the oil level is at the full level. SAE 10W-30 oil is recommended for general use.

Note: Do not thread the dipstick in when checking the oil level.

The SAE Viscosity Grade chart shows other viscosities to use in different average temperatures.

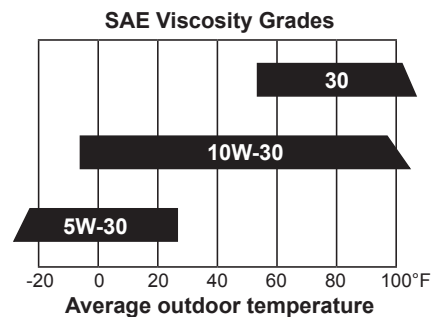

8. Thread the dipstick back in clockwise.

CAUTION! Do not run the engine with too little oil. The engine will be permanently damaged.

Air Filter Element Maintenance

1. Remove the air filter cover and the air filter elements and check for dirt. Clean or replace as described below.
2. **Cleaning:** Wash the element in warm water and mild detergent several times. Rinse. Squeeze out excess water and allow it to dry completely. Soak the filter in lightweight oil briefly, then squeeze out the excess oil.
3. Install the new filter or the cleaned filter. Secure the Air Cleaner Cover before use.

Spark Plug Maintenance

SAFETY

1. Disconnect spark plug cap from end of plug. Clean out debris from around spark plug.
2. Using a spark plug wrench, remove the spark plug.
3. Inspect the spark plug: If the electrode is oily, clean it using a clean, dry rag. If the electrode has deposits on it, polish it using emery paper. If the white insulator is cracked or chipped, the spark plug needs to be replaced.

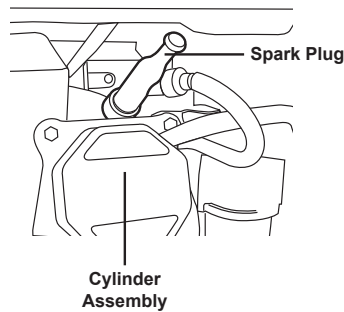

4. When installing a new spark plug, adjust the plug's gap to the specification on the Specifications chart. Do not pry against the electrode, the spark plug can be damaged.
5. Install the new spark plug or the cleaned spark plug into the engine. Gasket-style: Finger-tighten until the gasket contacts the cylinder head, then about 1/2-2/3 turn more. Non-gasket-style: Finger-tighten until the plug contacts the head, then about 1/16 turn more.

NOTICE: Tighten the spark plug properly. If loose, the spark plug will cause the engine to overheat. If overtightened, the threads in the engine block will be damaged.

6. Apply dielectric spark plug boot protector (not included) to the end of the spark plug and reattach the wire securely.

NOTICE: Using an incorrect spark plug may damage the engine. See the Specifications chart for your Generator for the type and gap required.

Storage

When the equipment is to remain idle for longer than 20 days, prepare the engine for storage as follows:

1. **CLEANING:**
Wait for engine to cool, then clean engine with dry cloth. **NOTICE: Do not clean using water.** The water will gradually enter the engine and cause rust damage. Apply a thin coat of rust preventive oil to all metal parts.

2. FUEL:



⚠ WARNING! TO PREVENT SERIOUS INJURY FROM FIRE:

Drain the fuel tank in a well-ventilated area away from ignition sources. If the engine is hot from use, shut the engine off and wait for it to cool before draining fuel.

Do not smoke.

- a. Place a funnel leading to a proper gasoline container below the carburetor.

- b. Remove the drain bolt from the bottom of the carburetor bowl and allow the fuel to drain.

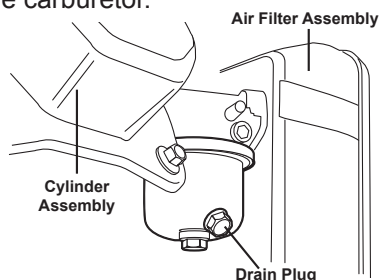

If present on your model, remove the small sediment cup next to the bowl and allow the fuel to drain from there as well.

- c. Open the fuel valve. After all fuel has drained, reinstall the drain bolt and sediment cup (if equipped). Tighten securely.

3. LUBRICATION:

- a. Change engine oil.
- b. Clean out area around spark plug. Remove spark plug and pour one tablespoon of engine oil into cylinder through spark plug hole.
- c. Replace spark plug, but leave spark plug cap disconnected.
- d. Pull Starter Handle to distribute oil in cylinder. Stop after one or two revolutions when you feel the piston start the compression stroke (when you start to feel resistance).

4. BATTERY:

Disconnect battery cables (if equipped). Recharge batteries monthly while in storage.

5. STORAGE AREA:

Cover and store in a dry, level, well-ventilated area out of reach of children. Storage area should also be away from ignition sources, such as water heaters, clothes dryers, and furnaces.

6. AFTER STORAGE:

Before starting the engine after storage, keep in mind that untreated gasoline will deteriorate quickly. Drain the fuel tank and change to fresh fuel if untreated gasoline has been sitting for a month, if treated gasoline has been sitting beyond the fuel stabilizer's recommended time period, or if the engine does not start.

SETUP

OPERATION

MAINTENANCE

Troubleshooting

Problem	Possible Causes	Probable Solutions
Engine will not start	FUEL RELATED: <ol style="list-style-type: none"> No fuel in tank or fuel valve closed. Choke not in CHOKE position, cold engine. Gasoline with more than 10% ethanol used. (E15, E20, E85, etc.) Low quality or deteriorated, old gasoline. Carburetor not primed. Dirty fuel passageways. Carburetor needle stuck. Fuel can be smelled in the air. Too much fuel in chamber. This can be caused by the carburetor needle sticking. Clogged Fuel Filter. 	FUEL RELATED: <ol style="list-style-type: none"> Fill fuel tank and open fuel valve. Move Choke to CHOKE position. Clean out ethanol rich gasoline from fuel system. Replace components damaged by ethanol. Use fresh 87+ octane unleaded gasoline only. Do not use gasoline with more than 10% ethanol (E15, E20, E85, etc.). Use fresh 87+ octane unleaded gasoline. Do not use gasoline with more than 10% ethanol (E15, E20, E85, etc.). Pull on Starter Handle to prime. Clean out passageways using fuel additive. Heavy deposits may require further cleaning. Gently tap side of carburetor float chamber with screwdriver handle. Turn Choke to RUN position. Remove spark plug and pull the start handle several times to air out the chamber. Reinstall spark plug and set Choke to CHOKE position. Replace Fuel Filter.
	IGNITION (SPARK) RELATED: <ol style="list-style-type: none"> Spark plug cap not connected securely. Spark plug electrode wet or dirty. Incorrect spark plug gap. Spark plug cap broken. Circuit breaker tripped (electric start models only). Incorrect spark timing or faulty ignition system. 	IGNITION (SPARK) RELATED: <ol style="list-style-type: none"> Connect spark plug cap properly. Clean spark plug. Correct spark plug gap. Replace spark plug cap. Reset circuit breaker. Check wiring and starter motor if breaker continues to trip. Have qualified technician diagnose/repair ignition system.
	COMPRESSION RELATED: <ol style="list-style-type: none"> Cylinder not lubricated. Problem after long storage periods. Loose or broken spark plug. (Hissing noise will occur when trying to start.) Loose cylinder head or damaged head gasket. (Hissing noise will occur when trying to start.) Engine valves or tappets mis-adjusted or stuck. 	COMPRESSION RELATED: <ol style="list-style-type: none"> Pour tablespoon of oil into spark plug hole. Crank engine a few times and try to start again. Tighten spark plug. If that does not work, replace spark plug. If problem persists, may have head gasket problem, see #3. Tighten head. If that does not remedy problem, replace head gasket. Have qualified technician diagnose/repair ignition system.

SAFETY

SETUP

OPERATION

MAINTENANCE



Follow all safety precautions whenever diagnosing or servicing the equipment or engine.

Troubleshooting (cont.)

SAFETY

SETUP

OPERATION

MAINTENANCE

Problem	Possible Causes	Probable Solutions
Engine misfires	<ol style="list-style-type: none"> 1. Spark plug cap loose. 2. Incorrect spark plug gap or damaged spark plug. 3. Defective spark plug cap. 4. Old or low quality gasoline. 5. Incorrect compression. 	<ol style="list-style-type: none"> 1. Check wire connections. 2. Re-gap or replace spark plug. 3. Replace spark plug cap. 4. Use only fresh 87+ octane unleaded gasoline. Do not use gasoline with more than 10% ethanol (E15, E20, E85, etc.). 5. Diagnose and repair compression. (Use Engine will not start: COMPRESSION RELATED section.)
Engine stops suddenly	<ol style="list-style-type: none"> 1. Low oil shutdown. 2. Fuel tank empty or full of impure or low quality gasoline. 3. Defective fuel tank cap creating vacuum, preventing proper fuel flow. 4. Faulty magneto. 5. Disconnected or improperly connected spark plug cap. 	<ol style="list-style-type: none"> 1. Fill engine oil to proper level. Check engine oil before EVERY use. 2. Fill fuel tank with fresh 87+ octane unleaded gasoline. Do not use gasoline with more than 10% ethanol (E15, E20, E85, etc.). 3. Test/replace fuel tank cap. 4. Have qualified technician service magneto. 5. Secure spark plug cap.
Engine stops when under heavy load	<ol style="list-style-type: none"> 1. Dirty air filter. 2. Engine running cold. 	<ol style="list-style-type: none"> 1. Clean or replace element. 2. Allow engine to warm up prior to operating equipment.
Engine knocks	<ol style="list-style-type: none"> 1. Old or low quality gasoline. 2. Engine overloaded. 3. Incorrect spark timing, deposit buildup, worn engine, or other mechanical problems. 	<ol style="list-style-type: none"> 1. Fill fuel tank with fresh 87+ octane unleaded gasoline. Do not use gasoline with more than 10% ethanol (E15, E20, E85, etc.). 2. Do not exceed equipment's load rating. 3. Have qualified technician diagnose and service engine.
Engine backfires	<ol style="list-style-type: none"> 1. Impure or low quality gasoline. 2. Engine too cold. 3. Intake valve stuck or overheated engine. 4. Incorrect timing. 	<ol style="list-style-type: none"> 1. Fill fuel tank with fresh 87+ octane unleaded gasoline. Do not use gasoline with more than 10% ethanol (E15, E20, E85, etc.). 2. Use cold weather fuel and oil additives to prevent backfiring. 3. Have qualified technician diagnose and service engine. 4. Check engine timing.
Product doesn't have power.	<ol style="list-style-type: none"> 1. Product not plugged in properly. 2. Circuit Breaker tripped. 3. Product needs service. 	<ol style="list-style-type: none"> 1. Turn off and unplug the product, then plug it back in again and turn on. 2. Turn off and unplug product, Reset Circuit Breaker. Plug in product and turn on. 3. Have product repaired.
Product begins to operate abnormally.	<ol style="list-style-type: none"> 1. Problem with appliance. 2. Rated load capacity exceeded. 	<ol style="list-style-type: none"> 1. Immediately unplug appliance. Have appliance repaired by a qualified technician, or replace appliance. 2. Lower the number of items plugged into the generator to stay within the rated capacity, or use a more powerful generator.



Follow all safety precautions whenever diagnosing or servicing the equipment or engine.

PLEASE READ THE FOLLOWING CAREFULLY

THE MANUFACTURER AND/OR DISTRIBUTOR HAS PROVIDED THE PARTS LIST AND ASSEMBLY DIAGRAM IN THIS MANUAL AS A REFERENCE TOOL ONLY. NEITHER THE MANUFACTURER OR DISTRIBUTOR MAKES ANY REPRESENTATION OR WARRANTY OF ANY KIND TO THE BUYER THAT HE OR SHE IS QUALIFIED TO MAKE ANY REPAIRS TO THE PRODUCT, OR THAT HE OR SHE IS QUALIFIED TO REPLACE ANY PARTS OF THE PRODUCT. IN FACT, THE MANUFACTURER AND/OR DISTRIBUTOR EXPRESSLY STATES THAT ALL REPAIRS AND PARTS REPLACEMENTS SHOULD BE UNDERTAKEN BY CERTIFIED AND LICENSED TECHNICIANS, AND NOT BY THE BUYER. THE BUYER ASSUMES ALL RISK AND LIABILITY ARISING OUT OF HIS OR HER REPAIRS TO THE ORIGINAL PRODUCT OR REPLACEMENT PARTS THERETO, OR ARISING OUT OF HIS OR HER INSTALLATION OF REPLACEMENT PARTS THERETO.

Parts List

Part	Description	Qty
1	Bolt, Flange	6
2	Cover Comp. Head	1
3	Packing, Head Cover	1
4	Tube, Breather	1
5	Bolt, Flange, 10×80	4
6	Rotator, Valve	2
7	Retainer, Valve Spring	2
8	Locker, Valve	4
9	Spring, Valve	2
10	Seat, Valve Spring	1
11	Seal, Valve Stem	1
12	Rocker Arm Assy., Exhaust	1
13	Rocker Arm Assy., Intake	1
14	Locker	4
15	Valve Rocker Shaft	2
16	Bolt, Stud, Exhaust	2
17	Spark Plug	1
18	Cylinder Head Comp.	1
19	Gasket, Cylinder	1
20	Pin, Dowel	2
21	Valve Assy.	1
22	Push Rod	2
23	Lifter, Valve	2
24	Bolt, Drain Plug	1
25	Washer, Drain Plug, M12	2
26	Oil Seal Φ35×Φ52×7	2
27	Crankcase	1
28	Cable Cleat	1
29	Bolt, Flange	1
30	Oil Level Switch	1
31	Bolt, Flange, M6x12	2
32	Alert Unit, Oil	1
33	Bolt, Flange, M6x12	1
34	Ring Set, Piston	1
35	Piston	1
36	Connecting Rod Assy	1
37	Pin, Piston	1
38	Clip, Piston Pin	2
39	Crankshaft Assy	1
40	Weight, Balancer	1
41	Camshaft Assy	1
42	Ball Bearing 6202	2
43	Ball Bearing 6207	1

Part	Description	Qty
44	Dowel Pin Φ8×12	2
45	Governor Kit	1
46	Gasket, Crankcase Cover	1
47	Crankcase Cover	1
48	Cap Assy	1
49	Bolt, Flange 8X40	7
50	Shroud	1
51	Bolt, Flange M6×12	1
52	Bolt, Stud, Exhaust	2
53	Packing, Carburetor	1
54	Insulator, Carburetor	1
55	Packing, Insulator	1
56	Carburetor Assy.	1
57	Packing., Air Cleaner	1
58	Nut, Flange	2
59	Air Cleaner Assy	1
60	Element, Air Cleaner Assy.	1
61	Clip, Harness	1
62	Grommet, Cord	1
63	Holder, Stop Switch	1
64	Coil Assy., Ignition	1
65	Bolt, Flange	2
66	Flywheel Comp. (Sel-Lamp)	1
67	Fan Cooling	1
68	Pulley, Starter	1
69	Nut Special, M16	1
70	Recoil Starter Comp.	1
71	Starter Assy.	1
72	Bolt, Flange, M6x12	5
73	Oil Seal, Φ8×Φ14×4	1
74	Shaft, Governor Arm	1
75	Washer, 8×16×1.2	1
76	Pin, Lock, M10	1
77	Control Assy.	1
78	Bolt, Flange, M6×12	2
79	Spring, Cable Return	1
80	Spring, Throttle Return	1
81	Rod, Governor	1
82	Arm, Governor	1
83	Bolt, Governor Arm	1
84	Nut, Flange M6	1
85	Cover, Dust	1
86	Bolt, Flange M5×10	3

Parts List (cont.)

SAFETY

SETUP

OPERATION

MAINTENANCE

Part	Description	Qty
87	Grommet, Crankcase	1
88	Bolt, Flange	4
89	Stay Comp., Muffler	1
90	Seal, Protector Muffler	1
91	Protector Comp., Muffler Inner	1
92	Muffler Assy.	1
93	Protector, Muffler Side	1
94	Bolt, Flange, 6×14	7
95	Protector Comp., Muffler Outer	1
96	Gasket, Ex., Pipe	1
97	Pipe, Comp., Ex.	1
98	Gasket, Ex., Pipe	1
99	Nut, Hex., M8	2
100	Bolt, Flange, 8×32	2
101	Fuel Tank	1
102	Cock Comp., Fuel	1
103	Cap Comp., Fuel Filler	1
104	Filter, Fuel Tank	1
105	Screw, Flat, M5×12	2
106	Meter Comp., Fuel	1
107	Tube, Fuel	1
108	Pipe Clip	2
109	Bolt, Flange, M6×25	4
110	Washer $\phi 6 \times \Phi 25 \times 2$	4
111	Collar, Tank Cushion	4
112	Rubber, Fuel Cushion	4
113	Rubber, Fuel Tank Mounting	2
114	Pipe	1
115	Pipe	1
116	Carbon	1
117	Bracket, Carbon	1
118	Ground Line	1
119	Alternator	1
120	Brush Assy.	1
121	Housing, Rr	1
122	Bolt, Flange	4
123	Bolt, Flange	2
124	Washer	1

Part	Description	Qty
125	Bolt, Flange	7
126	Avr	1
127	Bolt, Flange,	3
128	Cover, Generator End	1
129	Bolt, Hex.	1
130	Frame Comp., Side	1
131	Bolt, Flange	2
132	Stay, Air Cleaner	1
133	Frame Comp.	1
134	Rubber, Left	2
135	Rubber ,Right	2
136	Nut, Flange, M10	4
137	Nut, Flange, M8	4
138	Bolt, Flange	4
139	Rubber , Shock Absorber	4
140	Nut, Flange, M6	4
141	Pipe Clip	1
142	Pipe Clip	1
143	Pipe Clip	2
144	Tie, Cable	2
145	Case, Control Panel	1
146	Control Panel Assy.	1
147	Panel Output Indicator Light	1
148	Switch Assy., Combination	1
149	Socket	1
150	Protector	1
151	Protector(23A)	2
152	Terminal Set, Earth	1
153	Socket	2
154	Socket	1
155	Rectifier Brige	1
156	Protector(20A)	2
157	Rectifier	1
158	Fuse , Rectifier(5A)	1
159	Case, Fuse Connector	1
160	Waterproof Cover	2
161	Waterproof Cover	1
162	Waterproof Cover	5

Record Product's Serial Number Here: _____

Note: If product has no serial number, record month and year of purchase instead.

Note: Some parts are listed and shown for illustration purposes only, and are not available individually as replacement parts.

Assembly Diagram



SAFETY

SETUP

OPERATION

MAINTENANCE

Assembly Diagram (cont.)

SAFETY

SETUP

OPERATION

MAINTENANCE

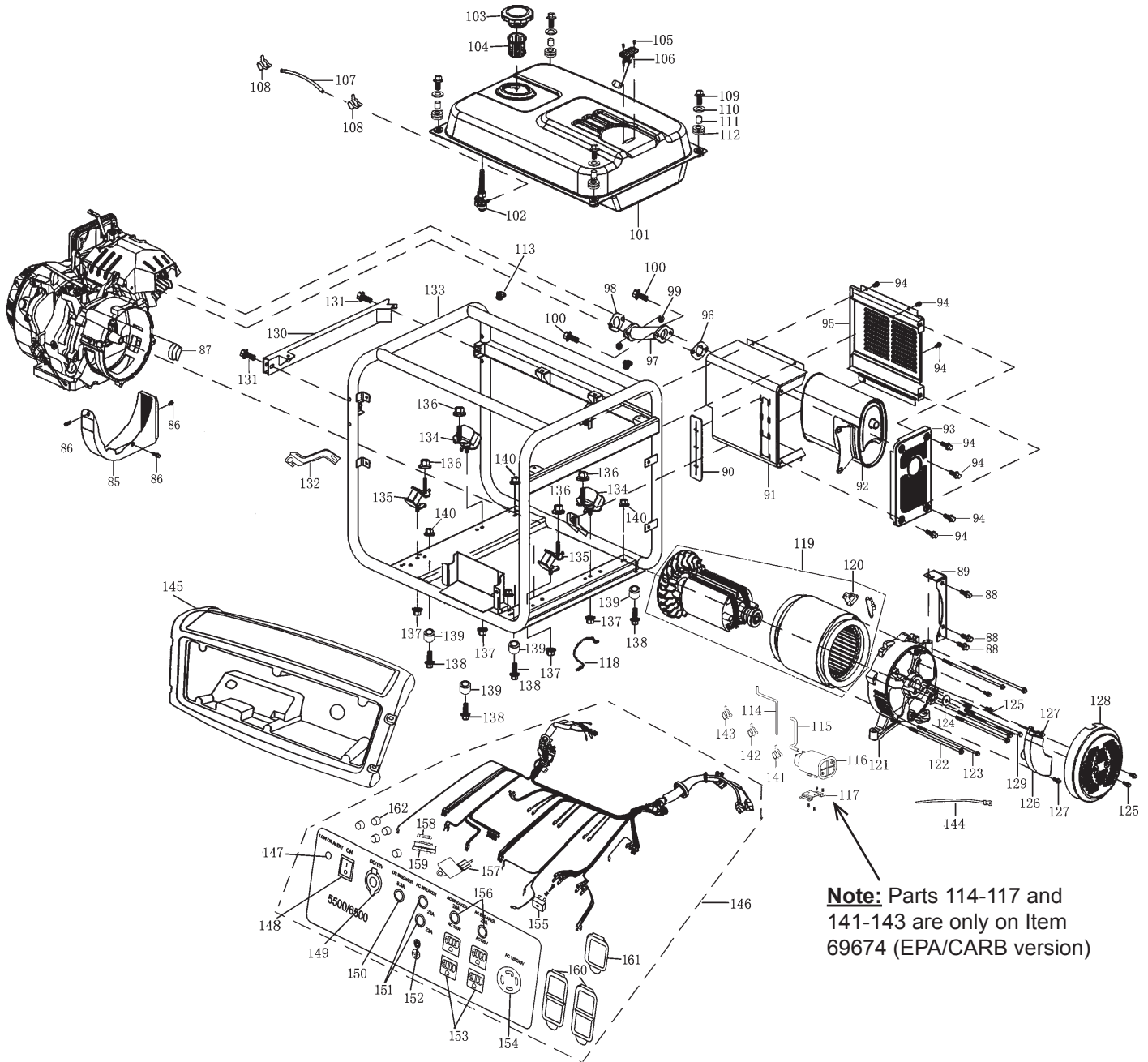

Note: Parts 114-117 and 141-143 are only on Item 69674 (EPA/CARB version)

Limited 90 Day Warranty

Harbor Freight Tools Co. makes every effort to assure that its products meet high quality and durability standards, and warrants to the original purchaser that this product is free from defects in materials and workmanship for the period of 90 days from the date of purchase. This warranty does not apply to damage due directly or indirectly, to misuse, abuse, negligence or accidents, repairs or alterations outside our facilities, criminal activity, improper installation, normal wear and tear, or to lack of maintenance. We shall in no event be liable for death, injuries to persons or property, or for incidental, contingent, special or consequential damages arising from the use of our product. Some states do not allow the exclusion or limitation of incidental or consequential damages, so the above limitation of exclusion may not apply to you. THIS WARRANTY IS EXPRESSLY IN LIEU OF ALL OTHER WARRANTIES, EXPRESS OR IMPLIED, INCLUDING THE WARRANTIES OF MERCHANTABILITY AND FITNESS.

To take advantage of this warranty, the product or part must be returned to us with transportation charges prepaid. Proof of purchase date and an explanation of the complaint must accompany the merchandise. If our inspection verifies the defect, we will either repair or replace the product at our election or we may elect to refund the purchase price if we cannot readily and quickly provide you with a replacement. We will return repaired products at our expense, but if we determine there is no defect, or that the defect resulted from causes not within the scope of our warranty, then you must bear the cost of returning the product.

This warranty gives you specific legal rights and you may also have other rights which vary from state to state.

Emission Control System Warranty

For Item 69674 (EPA/CARB version)

California and United States Emission Control Defects Warranty Statement

The California Air Resources Board (herein CARB), the United States Environmental Protection Agency (herein EPA), and Harbor Freight Tools (herein HFT) are pleased to explain the emission control system warranty on your 1995 and later Small Off-Road Engine (herein engine). In California, the engine must be designed, built and equipped to meet the State's stringent anti-smog standards. Elsewhere within the United States, new off-road, spark-ignition engines certified for model year 1997 and later, must meet similar standards set forth by the EPA. HFT must warrant the emission control system on your engine for the periods of time described below, provided there has been no abuse, neglect or improper maintenance of your engine.

Your emission control system may include parts such as the carburetor or fuel-injection system, and the ignition system. Also included may be hoses, belts, connectors and other emission-related assemblies.

Where a warrantable condition exists, HFT will repair your engine at no cost to you including diagnosis, parts and labor.

For Item 69672 (EPA version)

United States Emission Control Defects Warranty Statement

The United States Environmental Protection Agency (herein EPA) and Harbor Freight Tools (herein HFT) are pleased to explain the emission control system warranty on your 1997 and later Small Off-Road Engine (herein engine). Within the United States, new off-road, spark-ignition engines certified for model year 1997 and later, must be designed, built and equipped to meet the stringent anti-smog standards set forth by the EPA. HFT must warrant the emission control system on your engine for the periods of time described below, provided there has been no abuse, neglect or improper maintenance of your engine.

Your emission control system may include parts such as the carburetor or fuel-injection system, and the ignition system. Also included may be hoses, belts, connectors and other emission-related assemblies.

Where a warrantable condition exists, HFT will repair your engine at no cost to you including diagnosis, parts and labor.

For Both Items

Manufacturer's Warranty Coverage

The 1995 and later engines are warranted for two (2) years. If any emission-related part on your engine is defective, the part will be repaired or replaced by HFT.

Harbor Freight Tools Emission Control Defects Warranty Coverage

Engines are warranted for a period of two (2) years relative to emission control parts defects, subject to the provisions set forth below. If any emission related part on your engine is defective, the part will be repaired or replaced by HFT.

Owner's Warranty Responsibilities

- As the engine owner, you are responsible for the performance of the required maintenance listed in your Owner's Manual. HFT recommends that you retain all receipts covering maintenance on your engine, but HFT cannot deny warranty solely for the lack of receipts or for your failure to ensure the performance of all scheduled maintenance.
- As the engine owner, you should, however, be aware that HFT may deny you warranty coverage if your engine or a part has failed due to abuse, neglect, improper maintenance, or unapproved modifications.
- You are responsible for shipping your engine to a HFT warranty station as soon as a problem exists. Contact the HFT Customer Service department at the number below to make shipping arrangements. The warranty repairs should be completed in a reasonable amount of time, not to exceed 30 days.

If you have any questions regarding your warranty rights and responsibilities, you should contact the Harbor Freight Tools Customer Service Department at 1-800-444-3353.

Harbor Freight Tools Emission Control Defects Warranty Provisions

1. Length of Coverage

HFT warrants to a first retail purchaser and each subsequent purchaser that the engine is free from defects in materials and workmanship that cause the failure of warranted parts for a period of two (2) years after the date of delivery to the first retail purchaser.

2. No Charge Repair or Replacement

Repair or replacement of any warranted part will be performed at no charge to the owner if the work is performed through a warranty station authorized by HFT. For emissions warranty service, contact the HFT Customer Service Department at 1-800-444-3353.

3. Consequential Damages Coverage

Coverage under this warranty shall also extend to the failure of any engine components caused by the failure of any warranted part while it is still covered under this warranty.

4. Coverage Exclusions

Warranty claims shall be filed in accordance with the provisions of the HFT warranty policy explained in the box at the top of the previous page. HFT shall not be liable for any loss of use of the engine, for any alternative usage, for any damage to goods, loss of time, or inconvenience. Warranty coverage shall also be excluded for any part which fails, malfunctions, or is damaged due to failure to follow the maintenance and operating instructions set forth in the Owner's Manual including, but not limited to:

- a) Use of parts which are not authorized by HFT
- b) Improper installation, adjustment or repair of the engine or of any warranted part unless performed by an authorized warranty center
- c) Failure to follow recommendations on fuel use contained in the Owner's Manual
- d) Improper or inadequate maintenance of any warranted parts
- e) Repairs performed outside of the authorized warranty service dealers
- f) Alterations by changing, adding to or removing parts from the engine.

5. Service and Maintenance

Component parts which are not scheduled for replacement as required maintenance or are scheduled only for regular inspection to the effect of "repair or replace as necessary" are warranted for the warranty period. Any warranted part which is scheduled for replacement as required maintenance is warranted for the period of time up to the first scheduled replacement point for that part. Any replacement part, provided it is equivalent in durability and performance, may be used in performance of maintenance or repairs. The owner is responsible for commissioning a qualified technician/mechanic to perform all required maintenance, as outlined in the Inspection, Cleaning, and Maintenance section in this manual.

6. Warranted Parts

1) Fuel Metering System

- i) Carburetor and its internal parts.
- ii) Fuel pump (if so equipped).
- iii) Cold start enrichment system.

2) Air Induction System

- i) Intake pipe/manifold.
- ii) Air cleaner.

3) Ignition System

- i) Spark plug.
- ii) Magneto ignition system.

4) Catalyst System (if so equipped)

- i) Exhaust pipe stud.
- ii) Muffler.
- iii) Catalytic converter (if so equipped).

5) Miscellaneous Items Used in Above Systems

- i) Vacuum, temperature and time sensitive valves and switches.
- ii) Hoses, belts, connectors, and assemblies.

PREDATOR™
GENERATORS